

IS 345

DALI-2 APC - Aufputz eckig
EAN 4007841 010584
Art.-Nr. 010584

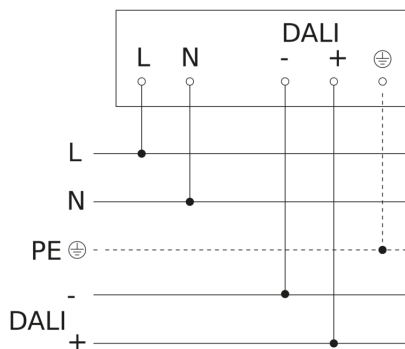

Schaltplan Master



Schaltplan Vernetzung DALI-2 APC mit DALI-2 IPD

